

Area floodlight luminaires

Floodlights with flat glass optic for full horizontal cut-off (meets the strictest UK national standards for the eradication of sky glow). High elevation peak beam angle for outstanding area coverage. 62 W or 140 W LED versions

Applications: car parks, airports, railways, security, amenity areas and commercial / retail or industrial sites.

- Aluminium heat sink ensures cool running of control gear and LEDs for optimum life in high ambient temperatures
- High elevation peak beam angle for outstanding area coverage relative to mounting height
- High beam efficiency with low glare
- Universal bracket for wall or column mounting
- Photocell option
- SmartScan wireless technology removes the need for control cabling. Ideal for retro-fit

Notes: Column top versions - Mounting pots or crossarms are required for this luminaire and must be ordered separately



IP65

Up to 120.3 LL/CW

SMARTSCAN

LED PROTECT

Specification

Mounting	Column	IP rating	IP65
Windage rating	0.1 m ²	Max presence detection height	8 m

Lighting

Optic	Clear cover	Lumen output	8,025 lm - 18,050 lm
Efficacy	Up to 120.3 LL/CW		

Power

LED power	62 W - 140 W	Circuit power	68 W - 150 W
-----------	--------------	---------------	--------------

LED characteristics

CRI	70+	Colour temperature	4000 K
Rated life (hours)	100 K - L90/B10		

Compliance

UKCA	Yes	CE	Yes
Energy efficiency class	This product contains a light source of energy efficiency class C		

Dimensions

Column top mounting

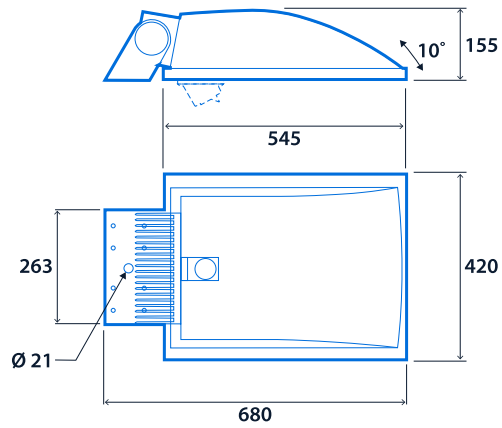

Wall mounting

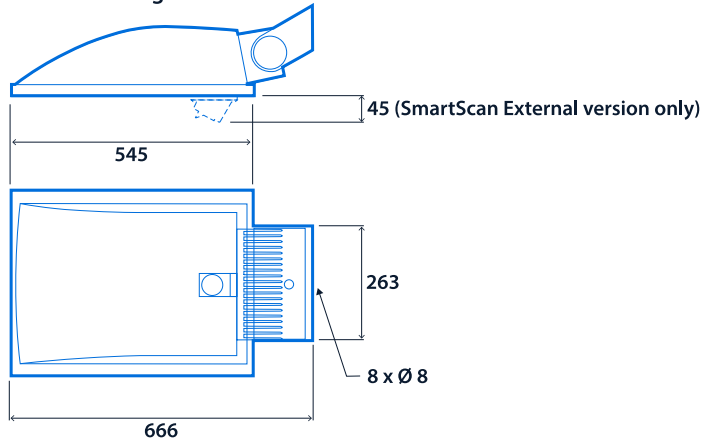

Click or scan here
View Starguard variants using
our online filtering tool



Information is correct as of 01-Jan-2025, however must not be interpreted as a guarantee of individual product performance and/or characteristics. We reserve the right to alter specifications and designs without prior notice.